

i²MON - Integrated monitoring for the detection of ground and surface displacements caused by coal mining

Daniel Schröder¹, Jörg Klonowski²

¹DMT GmbH & Co. KG, Am TÜV 1, 45307 Essen, Germany, (daniel.schroeder@dm-tgroup.com)

²Hochschule Mainz, Lucy-Hillebrand-Straße 2, 55128 Mainz, Germany, (joerg.klonowski@hs-mainz.de)

Key words: *multi-temporal 3D point cloud analysis; online monitoring; terrestrial laser scanning; slope monitoring; mining*

ABSTRACT

i²MON joins highly recognized European institutions to develop an integrated monitoring service for identification and assessment of ground and slope movements related to coal mining. i²MON is an RFCS-funded research project with a duration of 4 years, which started in July 2018. The service comprises innovative monitoring tools including terrestrial laser and radar technology as well as space- and airborne remote sensing. To understand the physical movement processes and in order to minimize mining impact, extensive predictive modelling will be directly integrated with the monitoring information. Finally merged into an integrated web-based system the service will substantially improve monitoring quality and costs and deliver the mining industry a key evaluation and decision-making instrument. The task of DMT and Mainz University of Applied Sciences in this project is to extend existing point-related sensor information (e.g. low-cost GNSS) with areal sensors. The focus here is on the use of a long-range laser scanning. Besides the integration of the scanner in a sensor network (data acquisition, data transfer), the focus is on the appropriate processing of the data. This means that according to the theoretical principles of deformation analysis, the focus is on a proper georeferencing of all sensors as well as a sophisticated stochastic model, so that systematic error influences and false alarms are minimized by an application-related modeling.

I. INTRODUCTION

The definition of monitoring is widely used in literature and interpreted in different ways by different scientific disciplines. Monitoring is basically the detection of all types of systematic changes in the object under observation (Heunecke *et al.*, 2013). In order to be able to detect geometric changes significantly, a monitoring program must be individually adapted to the object to be observed. Here it has to be considered that the object has to be spatially discretized according to the expected displacements. In addition to this restriction, temporal discretization must also be taken into account. This means that no significant shifts may occur during a measurement epoch and that no movements may remain unobserved due to the interval between two measurements. Due to the increasing selection of sensors, these disadvantages can be reduced (Schröder, 2018). According to (Heunecke *et al.*, 2013), the factors of spatial and temporal discretization can be classified as integrity characteristics of qualitative monitoring. For a proper monitoring two further characteristics have to be added. On the one hand the accuracy parameters, so that with the help of the sensors installed corresponding displacements can be significantly detected, and on the other hand the reliability parameters. In detail, this means that the necessary information are available at a required point in time,

thus enabling time-critical recommendations for immediate action.

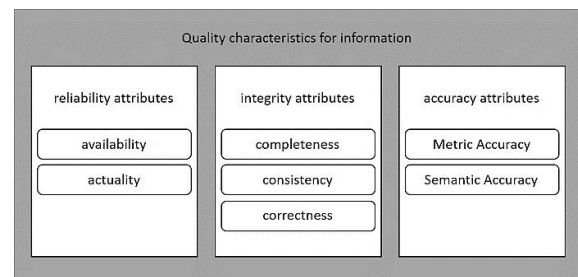

Figure 1. Quality characteristics for information (Heunecke *et al.*, 2013)

With cost-effective sensor technology, more measuring points can be installed or the development of area-based measuring systems such as the laser scanner can capture an object in an extended grid, which fundamentally simplifies the question of the spatial discretization of a measuring object. The modern development of communication devices and data management nowadays allow a high degree of automation, so that continuous measurements are possible, which is why a temporal discretization also becomes uncritical. These developments lead to an optimization regarding the compliance of all necessary criteria for information processing within a monitoring network.

II. SYSTEM DESCRIPTION

A. General Instructions

With terrestrial laser scanning it is possible to scan an object without contact and with a high point density. The company RIEGL from Austria offers for the surveying in open cast mining areas the model VZ-2000i, which was especially designed for use at long distances and in mining.



Figure 2. RIEGL laser scanner for surveying an opencast mine (RIEGL, 2019a)

In comparison to competing products, this laser scanner offers hardware that is optimized in terms of accuracy, integrity and reliability and is therefore excellently suited for use within a monitoring system. The aim of this project is to detect mine-induced displacements. On the one hand in underground areas and on the other hand above ground. Different sensors are suitable for different environments. The laser scanner is to be used for applications where slopes and embankments can be observed above ground. Large-scale infrastructure installations, including embankments, have so far mainly been observed using tachymetry. For this purpose, an object is equipped with prisms and thus spatially discretized. This means that movements can only be derived from these individual points and that information is interpolated between these points. In order to be able to use the prisms effectively, existing knowledge about the possible displacements must be integrated into the conceptual design. For instance, using the example of a dam, 40 individual points are used for deformation analysis and are illustrated in the following Figure 3. This procedure can be applied analogously to the use of GNSS sensors.

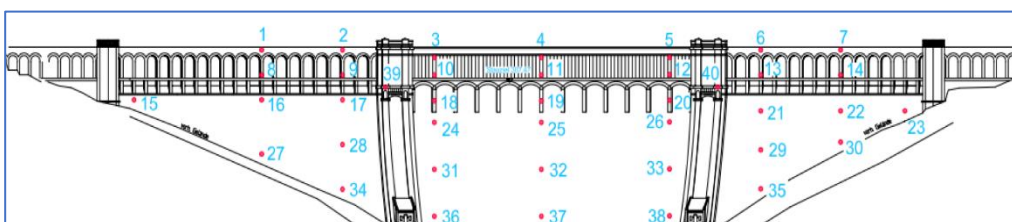

Figure 3. Spatial discretization of a dam using prisms for tachymetry (Müller *et al.*, 2016)

However, embankments are increasingly difficult to reach, so that non-contact measurement technology has the advantage that the object to be observed does not have to be entered directly and no prisms have to be attached. The measurement technology of a laser scanner is particularly suitable here. In addition, an object is scanned area-wide by a laser scan and the question of spatial discretization is of minor priority. In order to set up a monitoring system, no prior knowledge of the expected movement characteristics is required. In the following figure, the survey of the dam can be seen with the help of a laser scanner and the area coverage with measured values is clearly visible. The color of the image depends on the intensity values of the individual laser beams.

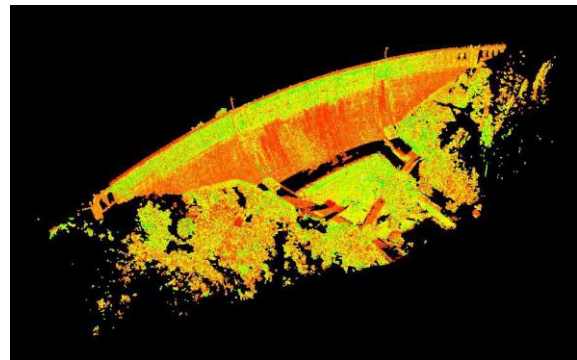

Figure 4. 3D laser scanning of a dam including the embankment areas (Müller *et al.*, 2016)

Most commercially available devices have a range that is within a few hundred meters, so that the scanner itself would have to be placed in the still endangered area. With the VZ-2000i, RIEGL offers a measuring device that has a range of up to 2500 m. Thus, the scanner can be stably installed outside the sphere of influence. For this reason, this hardware is particularly suitable for use in an early warning system to prevent hazards caused by mining induced landslides.

What makes the RIEGL VZ-2000i so special for use in this project? We try to classify the RIEGL VZ-2000i according to the following subsections and thus demonstrate its suitability for this project.

B. System Implementation

1) *Accuracy and Integrity:* As mentioned before, the VZ-2000i can measure objects with a very high accuracy up to a range of 2500 m contactless by digitizing the reflected echo signals and following "waveform analysis". The laser distance measurement is performed by high-precision pulse-time measurement. The evaluation with the help of "Waveform Analysis" is protected by RIEGL and is therefore exclusively available on the market. Not a special feature of geodetic monitoring, but important for use in public spaces, is the fact that the laser is specified according to Class 1 and is therefore eye-safe. RIEGL also provides a special "Waveform Data Output". In addition to the measurement results from the online analysis of the waveforms, waveforms of the target echoes can also be digitally recorded and output. Especially for research projects, these digitally recorded data of complex multi-target situations provide an excellent basis for scientific analysis and derivation of additional attributes. Another feature supports reliability as well as accuracy and integrity. In order to be able to detect targets at long distances at high laser pulse rates up to 1200 kHz and thus to adapt the temporal discretization during the observation of an object in the best possible way to the behavior of the object, the device uses the so-called "Multiple Time Around Processing, MTA" technology known from radar technology. This enables precise and clear distance measurements to be made using pulse propagation time measurement, even if several emitted laser pulses with several reflected target echoes of the laser pulses are simultaneously "in the air". RIEGL is also the exclusive user of this method, as it was developed by the company itself. With the help of a special software developed for this purpose, RiMTA TLS, the specifically modulated laser pulses are automatically reassigned to the correct target echoes. This procedure is protected by the Austrian patent.

2) *Reliability:* In addition to the procedure described above for improving the temporal discretization, the RIEGL scanner system also includes many other features that enhance reliability to a high degree. Regarding the integration within a monitoring system, RIEGL offers an interface via RiVLiB, which makes it possible to control and integrate the scanner via external software. A further interface is offered via the Python programming language. The functionality of the scanner can thus be considerably extended. The scanner can be operated remotely via 'cloud connectivity' and allows a data stream, so that the scanner can be operated via own developed software (e.g. DMT SAFEGUARD). These features make the hardware practicable for use within a monitoring system. Reliability is also supported by the compact and robust design in a dustproof and splash-proof housing (IP64). All these features make the VZ-2000i

from RIEGL a versatile measuring system that can be used to achieve the project goal.

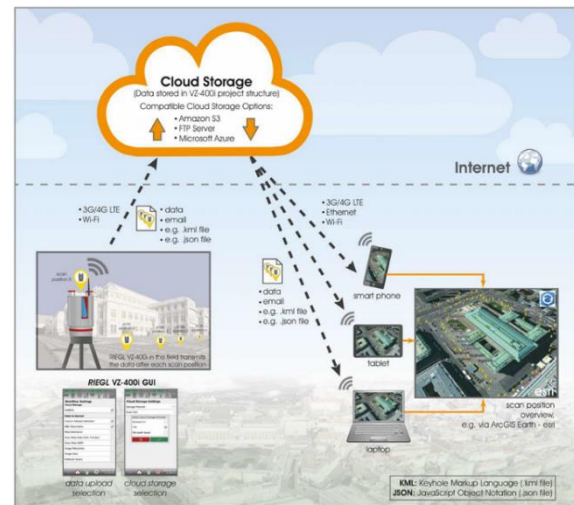

Figure 5. RIEGL VZ-2000i for surveying an opencast mine (RIEGL, 2019b)

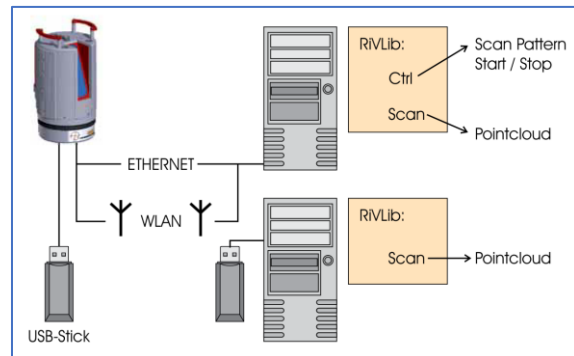

Figure 6. RIEGL VZ-2000i for surveying an opencast mine (RIEGL, 2019c)

C. Data Visualization

In addition to the requirements for the sensor technology itself, the general conditions for data integration, data storage and finally visualization must also be fulfilled. In the project, the web-based software product DMT SAFEGUARD, developed by DMT itself, will be used and further developed in a specific manner.

DMT SAFEGUARD combines all the requirements for a monitoring system as explained in Chapter 2. It offers the possibility of centrally storing a large amount of data and making it available to the user on a web-based basis. Thus it is possible for every user to operate his project platform-independently from any workstation that has a connection to the Internet. DMT SAFEGUARD is thus a modern, comprehensive database-driven software solution for monitoring tasks in geotechnics, geodesy, hydrogeology and geophysics.

DMT SAFEGUARD processes all types of sensor data in a single monitoring system, enabling the potential hazard area to be permanently monitored as part of professional risk management. An intelligent early

warning, alarm and reporting system permits the most effective reactions, while long-term monitoring enables the early detection of potentially dangerous trends for targeted hazard prevention. The special feature of this solution lies in the manufacturer-independent hardware connection of 'slow' geotechnical measurement series to 'fast' acoustic and video measurement series.

Also integrated is a document management system and a journal to preserve evidence of all measures and incidents. Depending on the stage of expansion, all measurement data and documents are consistently processed on the basis of a database, freely configurable messages and Internet-based access to the system as part of a GIS application.

III. DATA ANALYSIS

A. Introduction

The problems and challenges by using 3D point clouds from TLS measurements for deformation analysis are indicated in chapter II. A. and well summarized in (Wunderlich *et al.*, 2016). The following overview and methodologies for suitable deformation model for TLS observations stem from that article and has been further investigated at the University of Applied Sciences in Mainz.

In spite of increasing demand and application of TLS for areal deformation analysis in practice, the rigorous evaluation procedures are still under development and in most cases statistical tests of significance are missing. So assessments often are based only on visual representations (e. g. heat maps) and straightforward comparison of deformations with stated thresholds. Moreover, a couple of strategies purely return one-dimensional deformations from the 3D point clouds of two epochs.

The main reason for the deficiencies comes from the fundamental problem of how to compare two point clouds. In contrast to the unambiguous investigation into the 3D coordinate change of a defined point between two epochs, for surfaces various approaches with different prerequisites and algorithms are possible. (Mukupu *et al.*, 2016) and (Mill, 2016) distinguish three methods: point to point, point to surface and surface to surface. (Ohlmann-Lauber *et al.*, 2011) suggested a differentiation into five categories.

B. Data processing

1) *Point based strategies*: Very few point based strategies have won recognition of the scientific community. One of the few publications on the subject has been proposed (Little, 2016) where coordinates respectively distances are compared to repeated observations. This approach is hence a vectorial comparison in relation to the scanner's coordinate system. The reason why this strategy is not widespread can be justified by the fact that it is only

applicable if the viewpoint of the scanner remains constant. If this prerequisite cannot be justified, the point sampling in object space notably differs, so that it is not possible to repeatedly observe discrete points which have been acquired in a previous epoch.

2) *Point cloud based models*: In point cloud based models, relationships between point clouds are established by using coordinate transformations. The most common algorithm of this kind of model is the Iterative-Closest-Point-algorithm (ICP). (Girardeau-Montaut *et al.*, 2005) present three approaches for deformation monitoring. The key component of all methods is an octree structure (Samet, 2006) where a point cloud is subdivided into several cubes of equal size. Operations are carried out within all cells which is very efficient in terms of computational demand. As a prerequisite both point clouds must already be registered so that corresponding octree cells should contain data of the same area.

3) *Surface based approaches*: If the point clouds are modelled by building a surface consisting of point grids, the approach is surface based. Here, the corresponding points are either measured directly or they are interpolated. One of the first deformation models for point clouds has been proposed by (Cignoni *et al.*, 1998). Their algorithm performs point to surface inspection, nowadays mostly referred to as cloud-to-mesh (C2M) or cloud-to-model if a comparison to a priori known shape is made. As a first step a reference point cloud is triangulated while subsequently points are assigned to triangles based on which distances are computed. In a final step points can be colorized based on their distance to the reference surface. This procedure is the most popular approach for generating color coded inspection maps and is hence implemented in nearly every commercially available point cloud processing software. A common method for deformation monitoring in earth sciences has been proposed by (Lane *et al.*, 2003). Therefore, two point clouds are converted into gridded digital elevation models (DEM) while a point-wise comparison is carried out. (Schäfer *et al.*, 2004) applied TLS on a hydropower station where a lock chamber has been surveyed at different water levels. Data has been acquired from one viewpoint in all epochs while geometric changes have been derived as differences between interpolated grids based on the original point clouds. Hence, deformation can only be detected in one dimension which was suitable for this case.

4) *Geometry based methods:* Geometry based methods are characterized by approximating analytical or free-form surfaces to the laser scans to reveal areal deformations. In many cases, these surfaces are built by geometric primitives based on planes or quadrics. (Ioannidis *et al.*, 2006) compared a point cloud of a cooling tower to an approximated hyperboloid of one sheet and to non-uniform rational B-spline (NURBS) model. (Pesci *et al.*, 2015) parameterize the four walls of a historical tower as planes and determine the vertical displacement of this tower by analyzing the planes' inclinations. Although the investigations of (Eling, 2009) at monitoring a concrete dam have already been grouped as being point cloud based they can also be considered as a geometry based method: Since the point cloud is reduced to reproducible points by a plane adjustment, analytical surfaces are used to increase the accuracy of the latter deformation analysis (Neuner *et al.*, 2016). This example shows that the arrangement of the different deformation models listed in the beginning of the current section can be ambiguous in some cases.

5) *Parameter based procedures:* Parameter based procedures for deformation monitoring, as defined by (Ohlmann-Lauber *et al.*, 2016), are a special case of geometry based methods: Here, not the approximated analytical surface itself is of interest. Instead, the corresponding estimated parameters determine the deformation that is to be analyzed. In some cases, these parameters' significance is tested similar to common point based deformation analyses, e. g., based on a total station. (Holst, 2015) mounted a TLS on a sub-reflector of a 100 m radio telescope in order to reveal gravity evoked variations of its focal length. The captured point clouds were then parameterized by a rotational paraboloid, the estimated focal length determines the areal deformation. (Schneider, 2006) applied a long range laser scanner to monitor the bending line of a television tower. Therefore, the point cloud has been segmented by generating several slices of the conic tower. Each slice was approximated by a circle where the center point was monitored over time.

IV. RESEARCH WITHIN I²MON

A. Simulation and analysis of a landslide

To simulate a landslide, a model was created with the help of kinetic sand. The model consists of a wooden box with wooden bars. In the box there is sand, which is partly still held by the wooden bars. For registration there are reflectors at the edge of the box.

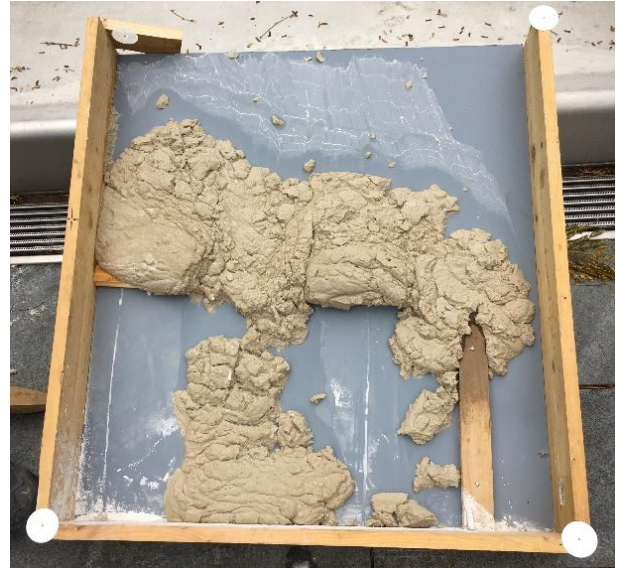

Figure 7. Simulation of landslide with the help of kinetic sand

A landslide is simulated by removing supporting bars and changing the inclination of the box. This causes the sand to slip slowly. The movement of the sand is not only a translation due to the wooden bars. Deformations of the sand also occur on the wooden bars.

B. Cloud to Cloud (C2C) method

The measurement with the RIEGL VZ-2000i laser scanner takes place in several epochs. The position of the laser scanner was not changed. In order to be able to compare the individual epochs, these have to be transformed into a unique coordinate system first. This so-called registration is done by using the reflectors. The accuracy of the registration is in the range of 0.2 to 5 mm (standard deviation of residues). A first comparison of the epochs was carried out with a cloud to cloud (C2C) method.

At first the result is visually evaluated (see Figure 8). With this method it is only possible to decide whether there had been movements of sand between the two epochs or not. A distinction between removal or addition of sand can't be given.

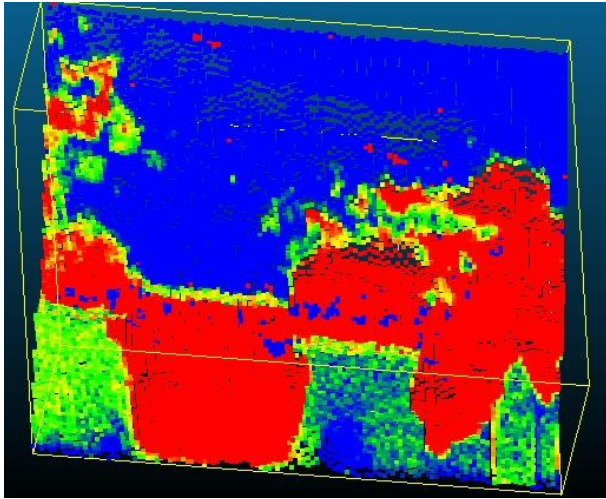

Figure 8. Cloud to Cloud comparison. Grey corresponds to no change. Blue corresponds to a slight change and red to a strong change.

C. Cloud to Mesh (C2M) method

A further investigation is carried out using the cloud to mesh (C2M) method (see Figure 9). A distinction between removal or addition of sand can already be made. The example shows how the slope has slipped in the upper area and how an addition has been created in the lower area. A significance test of the change has not yet taken place.

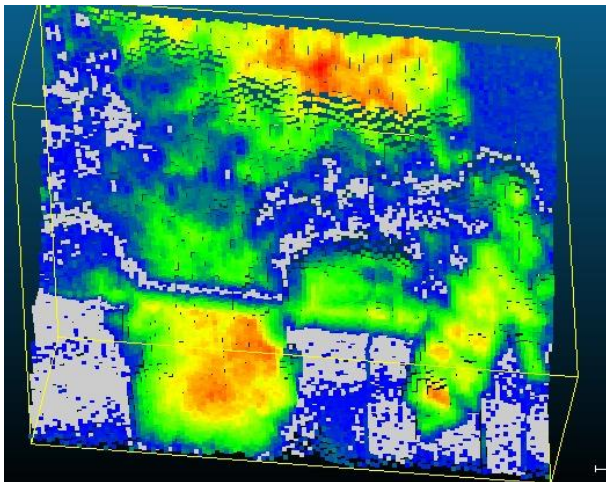

Figure 9. Cloud to Cloud comparison. Grey corresponds to no change. Blue corresponds to a slight change and red to a strong change.

D. Analysis using 3D feature descriptors

In order to make a clear statement regarding the movements of certain areas a further analysis was carried out with the measurement data. So-called 3D feature descriptors are used for this purpose. The idea is that identical points can be described between two epochs. Thus the exact translation of a point (or a group of points) can be determined.

Two algorithms were tested, first PFH (Point Feature Histogram, Rusu *et al.*, 2008) and RSD (Radius-based Surface Descriptors, Marton *et al.*, 2010). The first one calculates 4 features per point and compares them to

points in another point cloud using a histogram. The second compares the local curvature. In theory, it should be possible to find identical points that are not too deformed between epochs. First investigations have shown that these algorithms offer a high potential for application within a deformation analysis. However, further experimental tests are still needed so that a general conclusion can be derived.

E. Deformation analysis via plane fitting at a dam

In a monitoring project concerning a real dam a geometry based method was investigated. The dam wall was divided into smaller parts of equal size. In these areas, one best-fit plane was estimated per epoch (Eling, 2009). A measurement concept was developed that matches the corresponding technical regulations. Furthermore, the measured data can be evaluated within a classical deformation analysis. To assess the measurement concept, a series of observations were conducted in multiple epochs in the laboratory for 3D metrology in Mainz and at the Ennepetalsperre water dam (Müller *et al.*, 2016). To compare the two epochs, the distance of one point on the plane to the other plane was calculated. With the help of these methods deformations up to 0.01 m can be detected significantly. As a limitation, however, the method is suitable for objects with a smooth surface. In order to be able to use such a system reliably, however, questions concerning georeferencing and stochastic modelling must be further investigated.

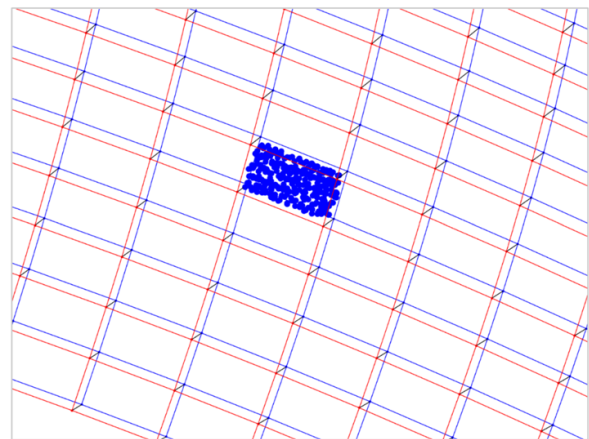

Figure 10. Representation of a voxel with data of the dam (Müller *et al.*, 2016)

V. CONCLUSION AND OUTLOOK

The project started 8 months ago and the first investigations as well as tests have shown a high potential for the use of a laser scanner within a spatial and time continuous monitoring system. The framework for the development of an integrated monitoring system is provided by the availability of hardware such as the RIEGL VZ-2000i or a software architecture within DMT SAFEGUARD.

The laser scanner will be integrated into an automated system so that research topics regarding

the reliability, accuracy and integrity of 3D point clouds can be addressed. For this reason, in addition to the implementation of an integrated system, further basic research work has to be clarified within this project.

The research work focuses on questions regarding the georeferencing, the multi-temporal comparison of point clouds especially within open pit mines.

Thus the current developments are:

- Cloud connectivity within a sensor network.
- The scanner within a multisensor system (e.g. combination with GNSS, climate sensors, inclination sensors).
- Different methods of georeferencing (e.g. point-based vs. geometry-based).
- Evaluation of the stochastic model of a scan (e.g. meteorological influences or reflection characteristics at different objects).
- Methods for multi-temporal analysis (e.g. Point based, Point cloud based, Surface based, Geometry based, Parameter based).

VI. ACKNOWLEDGEMENTS

This work was supported by the European Union Research Fund for Coal and Steel [Project Number 800689 (2018)].

Furthermore, we would like to thank RIEGL Laser Measurement Systems GmbH for the professional exchange and helpful hints within our research activities. Especially, TLS Business Division Manager, Dipl.-Ing. Nikolaus Studnicka.

In addition, we thank Denise Becker, Lukas Hart and Nils Kummert for their practical investigations on the use of RIEGL VZ-2000i and pointcloud processing in the described context during their M.Sc. programme at the University of Applied Sciences Mainz.

References

- Cignoni, P., C. Rocchini, R. Scopigno (1998). Metro: Measuring Error on Simplified Surfaces. In: Computer Graphics Forum, 17(1998)2, pp 167-174.
- Eling, D. (2009). Terrestrisches Laserscanning für die Bauwerksüberwachung (Dissertation). Online. Available: https://www.dgk.badw.de/fileadmin/user_upload/Files/DGK/docs/c-641.pdf. Accessed: 26- Mar- 2019.
- Girardeau-Montaut, D., M. Roux, R. Marc, G. Thibault (2005). Change detection on points cloud data acquired with a ground laser scanner. In: International Archives of Photogrammetry, Remote Sensing and Spatial Information Sciences, 36(2005)Part 3/W19, pp 30-35.
- Heunecke, O., H. Kuhlmann, W. Welsch, A. Eichhorn, H. Neuner (2013). Handbuch Ingenieurgeodäsie – Auswertung geodätischer Überwachungsmessungen, 2. Auflage (2013), Wichmann Berlin Offenbach, pp 1-48.
- Holst, C. (2015). Analyse der Konfiguration bei der Approximation ungleichmäßig abgetasteter Oberflächen auf Basis von Nivellements und terrestrischen Laserscans (Dissertation). Online. Available: https://dgk.badw.de/fileadmin/user_upload/Files/DGK/docs/c-760.pdf. Accessed: 26- Mar- 2019.
- Ioannidis, C., A. Valani, A. Georgopoulos, E. Tsiligiris (2006). 3D model Generation for Deformation Analysis using Laser Scanning data of a Cooling Tower. In: Proceedings of the 3rd IAG/12th FIG Symposium, May 22 – 24, 2006, Baden, Austria.
- Lane, S. N., R. M. Westaway, D. Murray Hicks (2003). Estimation of erosion and deposition volumes in a large, gravel-bed, braided river using synoptic remote sensing. In: Earth Surface Processes and Landforms, 28(2003)3, pp 249-271.
- Little, M. J. (2006). Slope monitoring strategy at PPRust open pit operation. In: Proceedings of the International Symposium on Stability of Rock Slopes in Open Pit Mining and Civil Engineering, Cape Town, South Africa, pp 221-230.
- Marton, Z. C., D. Pangercic, N. Blodow, J. Kleinhellefort, M. Beetz (2010). General 3d modelling of novel objects from a single view, in: IEEE/RSJ International Conference on Intelligent Robots and Systems, 2010, pp. 3700-3705.
- Mill, T. (2016). Simulation of terrestrial laser scanning errors occurring during deformation monitoring. In: Proceedings of the 3rd Joint International Symposium on Deformation Monitoring (JISDM), March 30 –April 01, 2016, Vienna, Austria. CD-ROM.
- Mukupi, W., G.W. Roberts, C.M. Hancock, K. Al-Manasir (2016). A review of the use of terrestrial laser scanning application for change detection and deformation monitoring of structures. In: Survey Review, 48(2016), pp 1-18.
- Müller, M., F. Schmenger, D. Schröder, K. Zschiesche (2016). Evaluierung eines modernen Messverfahrens zur Deformationsanalyse flächenhafter Ingenieurbauwerke am Beispiel der Ennepetalsperre. In: Scientific Reports der Hochschule Mittweida, Messtechnische Überwachung von Stauanlagen, Nr. 2, 2016, ISSN 1437-7624, pp 27-35.
- Neuner, H., C. Holst, H. Kuhlmann (2016). Overview on Actual Modelling Strategies of Point Clouds for Deformation Monitoring. In: Allgemeine Vermessungs-Nachrichten (avn), 123(2016)11-12, pp 328-339.
- Ohlmann-Lauber, J., T. Schäfer (2011). Ansätze zur Ableitung von Deformationen aus TLS-Daten. In: 106. DVW Seminar Terrestrisches Laserscanning – TLS 2011, Wißner, Augsburg, pp 161-180.
- Pesci, A., G. Teza, E. Boschi (2015). Laser scanning-based detection of morphological changes of a historical building occurred during a seismic sequence: Method and case study. In: International Journal of Geomatics and Geosciences, 5(2015)3, pp 427-447.
- RIEGL Laser Measurement Systems GmbH (2019a). Mine Surveying at Kalgoorlie gold mine, Australia, using the RIEGL VZ-400i 3D Terrestrial Laser Scanner. Online. Available: http://www.riegl.com/fileadmin/user_upload/Members-Area-Folder/Photo_Gallery/Terrestrial_Scanning/VZ-400i_Mining_2.jpg. Accessed: 26- Mar- 2019.

- RIEGL Laser Measurement Systems GmbH (2019b). RIEGL VZ-2000i Datasheet. Online. Available: http://www.riegl.com/uploads/tx_pxriegl/downloads/RIEGL_VZ-2000i_Datasheet_2017-12-18_Preliminary.pdf. Accessed: 26- Mar- 2019.
- RIEGL Laser Measurement Systems GmbH (2019c). RIEGL Interface Software RiVLib Datasheet. Online. Available: http://www.riegl.com/uploads/tx_pxriegl/downloads/Datasheet_RiVLIB_2014-09-17_01.pdf. Accessed: 26- Mar- 2019.
- Rusu, R. B., Z. C. Marton, N. Blodow, M. Beetz, I. A. Systems (2008). T. U. München, Persistent point feature histograms for 3d point clouds, In: Proceedings of the 10th International Conference on Intelligent Autonomous Systems, IAS-10, 2008.
- Samet, H. (2006). Foundations of Multidimensional and Metric Data Structures. Kaufmann, San Francisco, CA.
- Schäfer, T., T. Weber, P. Kyrinovic, M. Zámečnikivá (2004): Deformation measurement using terrestrial laser scanning at the hydropower station of Gabčíkovo. In: INGEO 2004 and FIG Regional Central and Eastern European Conference on Engineering Surveying, November 11 – 13, 2004, Bratislava, Slovakia. CD-ROM.
- Schneider, D. (2006). Terrestrial laser scanning for area based deformation analysis of towers and water dams. In: Proceedings of the 3rd IAG/12th FIG Symposium, May 22 – 24, 2006, Baden, Austria.
- Schröder, D. (2018). Der Paradigmenwechsel in der Ingenieurgeodäsie - Zeit- und raumkontinuierliche Messwerterfassung an Ingenieurbauwerken. In: Scientific Reports der Hochschule Mittweida ,Messtechnische Überwachung von Stauanlagen, Nr. 1, 2018, ISSN 1437-7624, pp 84-91.
- Wunderlich, T., W. Niemeier, D. Wujanz, C. Holst, F. Neitzel, H. Kuhlmann (2016). Areal Deformation Analysis from TLS Point Clouds – The Challenge. In: Allgemeine Vermessungs-Nachrichten (avn), 123 (2016) 11-12, pp 340-350.